



T&S BRASS AND BRONZE WORKS, INC.

2 SADDLEBACK COVE / P.O. BOX 1088 / TRAVELERS REST, SC 29690

PHONE 800-476-4103

FAX 864- 834-3518



REG.#A2601  
ISO #9001

Model No.

B-7243-05

Item No.:

Job Name:

Architect/Engineer Approval:

Notes:

MV-2522-24 FRONT TRIGGER STYLE GUN  
WITH RETRACTABLE HOLD DOWN CLIP,  
STAINLESS STEEL BODY AND ROYAL  
BLUE RUBBER COVER

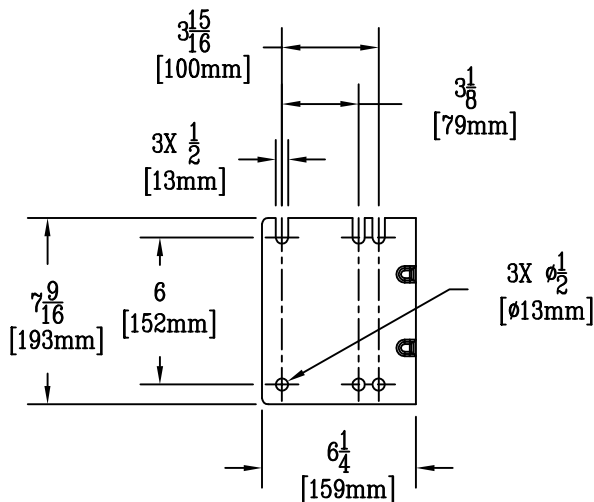
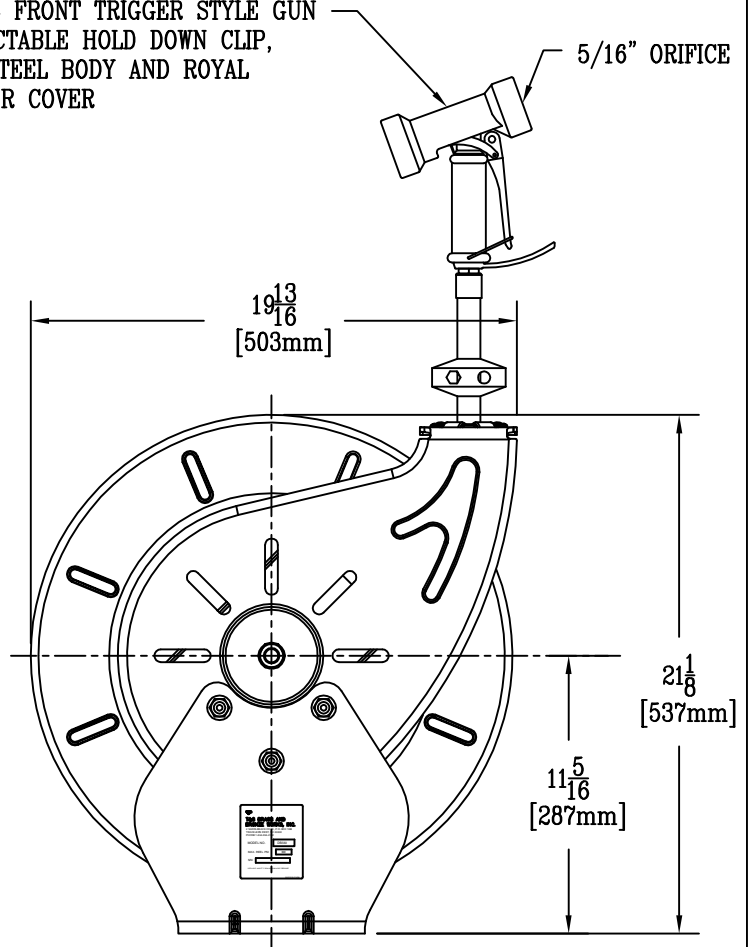
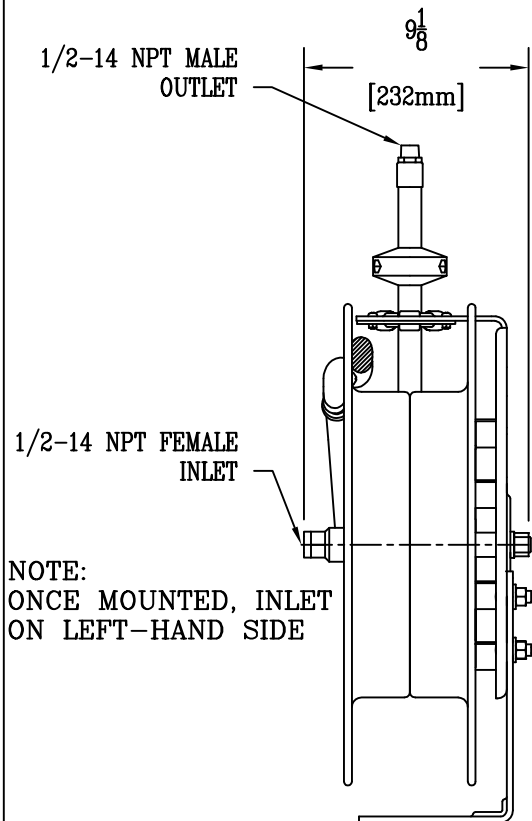

Product Description:  
HOSEREEL, OPEN, EPOXY POWDER COATED STEEL  
50 FT OF 1/2 DIA. BLUE HOSE AND  
MV-2522-24 FRONT TRIGGER, 5/16" SPRAY GUN

Drawn:

JRM

Checked

JHB

Scale:

1 : 8

Approved

JHB

Date:

6/09/05